



Pressure relief valves 3 – 15 bar

Pressure relief valves applied in sprayers are ensuring a maximum pressure in order to prevent any bursting hoses or components.

altek offers fix adjusted relief valves applicable for various pressure levels. The valve housing with AS40 connectors allows an easy and cost saving assembly process.

Due to the big cross section and the aerodynamic housing they can be used for outputs of 400 l/min. For all that, they are very firm and well fitted to the altek Quick-Fit system.





Überdruckventile 3 – 15 bar

altek bietet ab Werk fest eingestellte Überdruckventile für unterschiedliche Druckniveaus an. Das Ventilgehäuse ist mit AS40 Anschlüssen ausgestattet. Dadurch ist auch hier eine einfache und kostengünstige Montage gesichert.

Durch die großen Querschnitte und der störungsfreien Durchströmung sind sie für Volumenströme bis zu 400 l/min geeignet.

Dank ihrer besonderen Bauform sind sie dennoch kompakt und lassen sich hervorragend ins altek Quick-Fit System integrieren.

Overview *Übersicht*

Article no. <i>Artikel-Nr.</i>	Opening pressure <i>Öffnungsdruck</i>	D, mm	Colour <i>Farbe</i>
83275	3 bar	33	
83276	6 bar	33	
81493	10 bar	25	
84342	10 bar	AS40	
82994	15 bar	25	



- **Safe and quick assembly using the altek plug-in system**
Schnelle und sichere Montage durch die Verwendung des altek Stecksystems
- **Fully integratable with Modular-Fit and Quick-Fit valve series**
Vollständige Integration in die Modular-Fit- und Quick-Fit Serie

Basic parameters *Eigenschaften*

Flow rate <i>Durchfluss</i>	100 — 400 l/min
Material	Stainless steel, POM GF, FPM- and NBR seals Edelstahl, POM GF, FPM- und NBR-Dichtungen

Design *Ausführung*

Zweifache Kolbenabdichtung
Twofold piston sealing

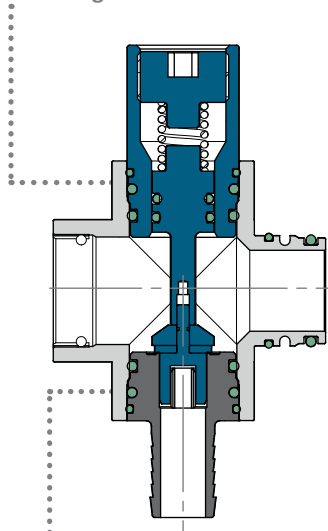

Piston guide
Kolbenführung

Dimensions *Abmessungen*

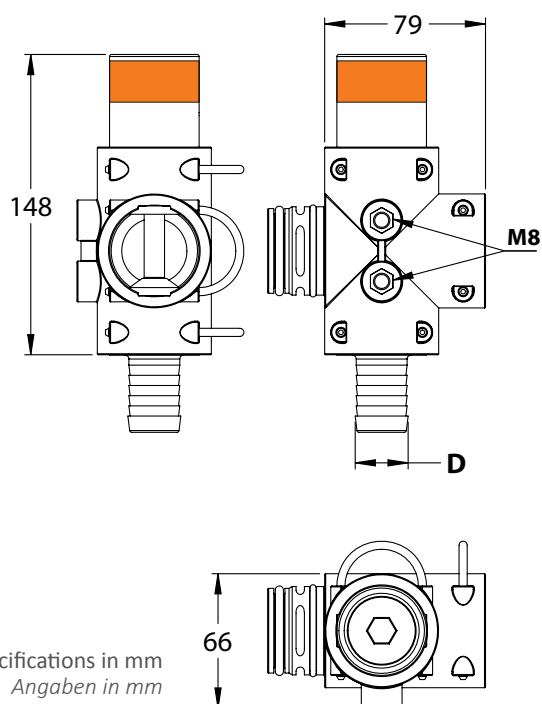

Fittings

AS40

Fittings 111 ff.

Cross piece Kreuzstück

Standard

T piece T-Stück

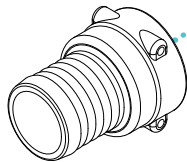

Article no. Female hose tail
Artikel-Nr. Stülptülle

80354	AS40 / \varnothing 20
80357	AS40 / \varnothing 25
34232	AS40 / \varnothing 33
34231	AS40 / \varnothing 39

81655	AS40 / \varnothing 20 / 90°
81654	AS40 / \varnothing 25 / 90°
81653	AS40 / \varnothing 33 / 90°
81652	AS40 / \varnothing 39 / 90°

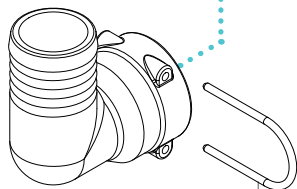

Article no. Safety Pin
Artikel-Nr. Sicherungsstecker

18545	AS24
02632	AS30
05241	AS40

Article no. Female hose tail
Artikel-Nr. Stülptülle

82250	AS24 / \varnothing 13 / 90°
80349	AS24 / \varnothing 15 / 90°
80780	AS24 / \varnothing 16 / 90°
81791	AS24 / \varnothing 17 / 90°
80350	AS24 / \varnothing 20 / 90°
80781	AS24 / \varnothing 22 / 90°
83588	AS30 / \varnothing 20 / 90°

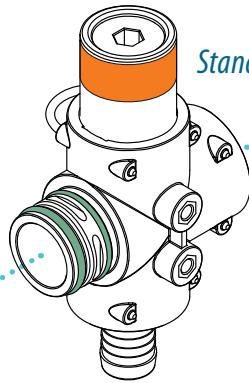

Article no. Male hose tail
Artikel-Nr. Stecktülle

80353	AS40 / \varnothing 20
04595	AS40 / \varnothing 25
04581	AS40 / \varnothing 33
06247	AS40 / \varnothing 39

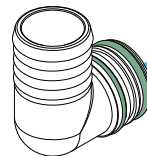

80352	AS40 / \varnothing 20 / 90°
09184	AS40 / \varnothing 25 / 90°
08874	AS40 / \varnothing 33 / 90°
08275	AS40 / \varnothing 39 / 90°

Article no. Dummy plug
Artikel-Nr. Blindstopfen

80333	AS40
-------	------

Article no. Adapter AS / AS
Artikel-Nr.

80412	AS40 / AS24
83458	AS40 / AS30
81602	AS40 / AS40

Article no. Female hose tail
Artikel-Nr. Stülptülle

34230	AS24 / \varnothing 15
34229	AS24 / \varnothing 17
34227	AS24 / \varnothing 20
47934	AS24 / \varnothing 25
34234	AS30 / \varnothing 20
34233	AS30 / \varnothing 25

